

# Piezo Ceramics DC-AC Inverter

## Specification

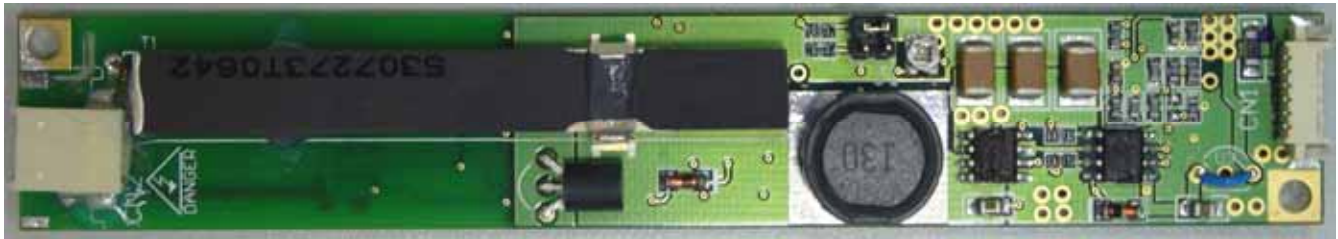

*Note: Actual product image may be different.*

Model	FC01-12-06
Part No.	400-8888-010
Description	1 lamps with wide range dimming control Independent open lamp protection
Customer	
Hardware Rev	1.0
Document Rev	1.2

Approved by	Verified by	Prepared by
Eddie	Bart	Queenie



**Zippy Technology Corp.**  
**Zippy USA Inc.**

TEL: 886-2-2918-8512  
TEL: 1- 973-463-9499

e-mail: [ceramicsales@zippy.com.tw](mailto:ceramicsales@zippy.com.tw)  
e-mail: [edward@zippy.com](mailto:edward@zippy.com)  
Manufacture Number: D008888010

## Revision Record

Request Document No.	Date	Page	Item	Description	Revision
FC09172006	9/17/2006	1		Change Document Rev to 1.1 Consolidate pin 1 definition on page 6 & 8	1.1
FC12272006	12/27/2006	5	2.2	Change Document Rev to 1.2 Correction Environmental Characteristic	1.2
		6	5.1	Correction Production tests	
		7	5.2	Deletion Typical duty cycle	
		7	6.1	Correction Applicable safety standards	
		7	7.1	Correction Label Set	

## 1. General:

Piezoelectric ceramics are used to convert electric energy to mechanical energy and vice versa. Piezoelectric transformer can generate a high voltage output by a low voltage input through the utilization of mechanical resonance and magnification phenomenon of the piezoelectric transducer.

### 1.1 Principle:

The piezoelectric transformer has primary and secondary electrodes on the piezoelectric ceramics. The primary side is polarized in the thickness direction and secondary side is polarized in the length direction. When a voltage with the resonance frequency is applied on the primary side, a strong mechanical vibration is generated by “inverse piezoelectric effect” of the ceramics, and a high voltage is output from the secondary side, matching its vibration frequency by “direct piezoelectric effect”.

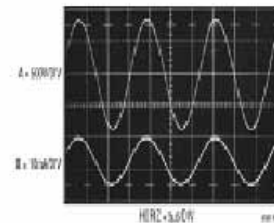
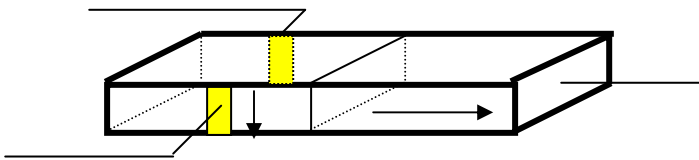

### 1.2 Advantages & special features:

- No EMI (Piezo ceramics)
- > 85% High efficiency
- Inflammability (no liability)
- Wide range no flicker dimming
- One size fits all
- Constant current mode
- Wide operating temperature -40 to +85
- Independent open lamp protection
- Independent short circuit protection
- Balanced sine wave output, no harmonic current noise
- Balanced sine wave output, ultra low harmonic current noise
- Short start up time, extended CCFL lifespan
- Open lamp and short circuit protection
- Built-in Arc Protection
- 100% full load test
- Compact Size, high reliability
- Low heat generation
- UL approval E304655
- RoHS compliant with Piezo ceramic exemption

\*Spec subject to models

## 2. Detailed specification:

### 2.1 Electrical characteristics (Ta=25±5 )

	ITEM		TEST	Min.	Typ.	Max.	Unit	Notes
1	Input voltage	Vin	-	10.8	12	13.2	v	
2	Input current	Min	D <sub>PWM</sub> =0% & V <sub>IPWM</sub> =5V	-	0.1	-	A	
		Max	D <sub>PWM</sub> =100% & V <sub>IPWM</sub> =0V	-	0.44	-		
3	Input Inrush Current	-	D <sub>PWM</sub> =100% & V <sub>IPWM</sub> =0V	-	-	2	A <sub>peak</sub>	Initial power on only.
4	Output Inrush Current	-	D <sub>PWM</sub> =50%	-	-	11	mA <sub>peak</sub>	
5	Total Output Current	I <sub>out</sub>	D <sub>PWM</sub> =100% & V <sub>IPWM</sub> =0V	5.5	6.0	6.5	mA	
6	Individual Output Current	Min	D <sub>PWM</sub> =0% & V <sub>IPWM</sub> =5V	≥ 0	≤ 0.5	≤ 1	mA	Low volt side of LOAD
		Max	D <sub>PWM</sub> =100% & V <sub>IPWM</sub> =0V	5.5	6.0	6.5		
7	Oscillating Frequency	F <sub>w</sub>	-	50	53	60	KHz	
8	Minimum Duty Ratio	D <sub>min</sub>	D <sub>PWM</sub> =D <sub>min</sub>	-	-	-	%	
9	On/Off Control Voltage	On	-	1.8	-	5	v	
		Off	-	0	-	1.7	v	
10	On/Off Control Current	I <sub>B<sub>LON</sub></sub>	-	5	-	10	mA	
11	Internal DC Control Voltage	Min	-	-	5	-	v	Duty Ratio ≤ 1%
		Max	-	-	0	-	v	Duty Ratio=100%
12	Internal DC Control Current	I <sub>IPWM</sub>	-	-	5	-	mA	
13	Open Lamp Voltage	V <sub>s</sub>	Ta=-20	TBD	-	3500	V <sub>rms</sub>	Under B/L condition
			Ta=0	2820	-	3500		
			Ta=25	2090	-	4000		
14	Lamp Voltage	V <sub>w</sub>	-	700	750	800	V <sub>rms</sub>	*120KΩ load
15	DC Bias Level	I <sub>DC</sub>	-	-	-	10	%	I <sub>peak</sub> - I <sub>-peak</sub>  /I <sub>L</sub>

Note: Lamp voltages are measured with a simulated resistive load. Piezo inverter will automatically adjust output voltage to compensate for load changes caused by lamp manufacturing tolerance, ambient temperature, lamp aging and etc.

## 2.2 Environmental Characteristic:

Storage Temperature	: -40 ~+85	Operating Temperature:	-40 ~+85
Storage Humidity	: 90% Max	Operating Humidity	: 90% Max
(RH Non-condensation)			

## 2.3 Protection Mechanism:

Condition	Test Method	Protection	NOTE
Over Voltage	Open Lamp	Shutdown	0.1S<T <sub>fault</sub> <2S
Over Current	Input Shutter	Shutdown	
Output Short	Output Shutter: 2K	Shutdown	
Arcing	Transformer Open	Shutdown	

## 3.Application Notes:

- 3.1 Always connect output loading before turning on the unit to avoid damages.
- 3.2 Avoid over stressing the high voltage output connector by using short wire.
- 3.3 Avoid bending, twisting or applying any pressure to the PCB and Piezo transformer.

## 4. Typical Application:

LCD-TV, LCD-Monitor CCFL backlight

### 4.1 Input connector pin assignment:

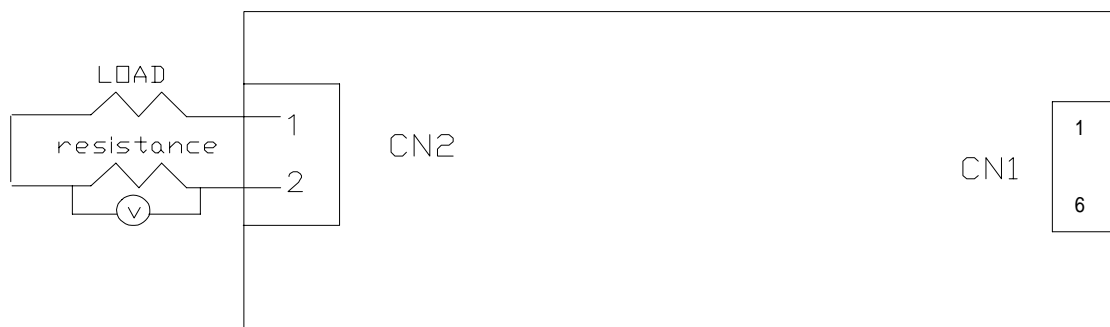

**Input: CN1 [MOLEX 53261-0690]**

Pin	Signal name	Function
1, 2	VIN	+12V
3	VADJ	0 to +5V voltage level or 100-1000Hz 0 to +5V PWM
4	ON/OFF	+5V / 0V
5, 6	GND	Ground

**Voltage level dimming: 0V Brightest, +5V Dark**

## 4.2 Output connector pin assignment:

**Output: CN2 [JST SM02B-BHSS-1-TB]**

Pin	Signal name	Function
1	CFL HOT	CFL High voltage
2	CFL COLD	CFL Low Voltage

\*Wrong connections will cause electric shock and also break down of the product.

## 5. Reliability

### 5.1 Production tests

	Test item	Test condition	Criteria
1	Low temp. Operation	Ta=-40 500 hr.	Measurement must be performed 1 hr. after taken out from the chamber. Must meet initial performance except CCFL deterioration.
2	High temp. Operation	Ta=+85 500 hr.	
3	High temp & Humidity	Ta=50 , 80%RH, 1000 hr.	
4	Low temp. Storage	Ta=-40 , 240hr. Non operation	Measurement must be performed 4 hr. after taking out from the chamber. Must meet initial performance except CCFL deterioration.
5	High temp. Storage	Ta=+85 , 240hr. Non operation	
6	Thermal shock	Ta=-20 , 30min.<->+60 , 30min. 200 cycles, non operation, Transition duration less than 3 min.	Measurement must be performed 4 hr. after taking out from the chamber. Must meet initial performance except CCFL deterioration.
7	On-Off Cycle	Ta=25 ± 3 500 hr., 10[s] ON, 10[s] OFF 100,000 cycles	Must meet Initial performance except CCFL deterioration.
8	Shock	100G 11mSec. Half-sine pulse 1time each axis X, Y, Z,	No noticeable changes allowed
9	Vibration	10~57Hz, Amplitude 0.75mm 57~500Hz 2G Sweep: 11 min.,60 min. each axis X, Y, Z,	No noticeable changes allowed

## 6. Safety requirements

### 6.1 Applicable safety standards

- UL 60950-1:2003
- CSA C22.2 NO.60950-1-03
- IEC60950-1:2001
- EN 60950-1:2001

### 6.2 Abnormal tests

There must be no smell, smoke and fire cause by any failure on the inverter circuit. All components open/short test must be performed and reported. Especially, should not rely on a fuse or an over load protection function of the power supply.

### 6.3 Limited current circuit

The inverter conforms to IEC60950 limited current circuit spec and is UL approved with file number: E304655.

## 7. Additional notes:

### 7.1 Label position (Reverse side of PCB)

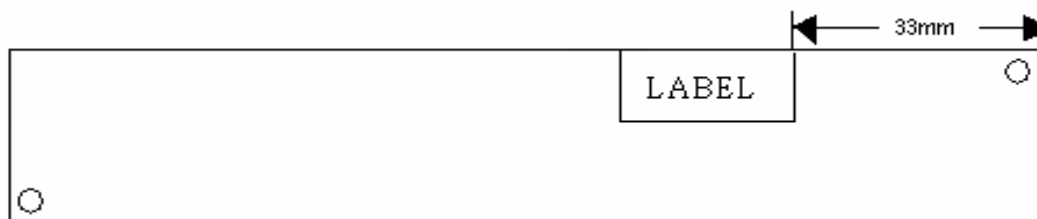

Label: Includes model, part number and data code.

Model
Part No
Data code

## 7.2 Data code (example):

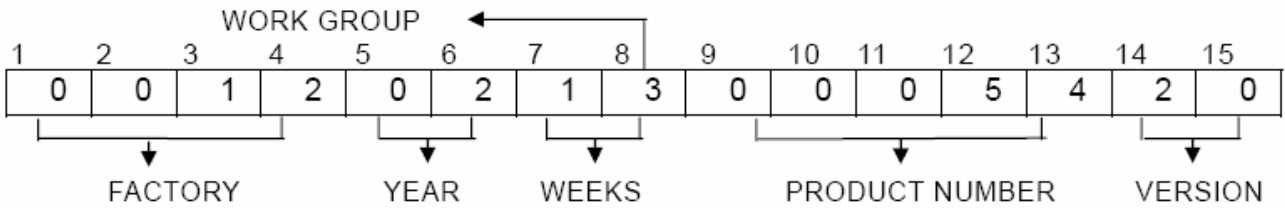

## 8. PCB layout:

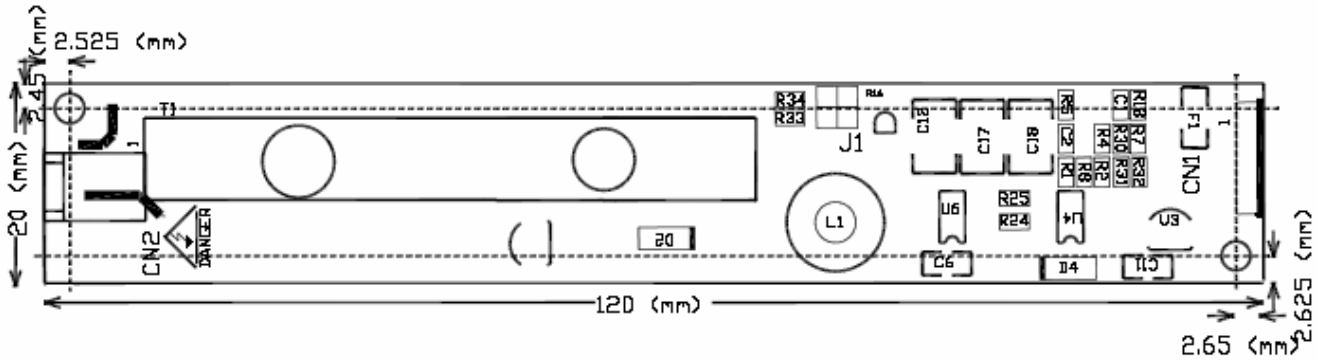

### NOTES:

1. PCB Board general tolerance:  $\pm 0.1\text{mm}$
2. Hole tolerance:  $\pm 0.1\text{mm}$
3. Base board thickness: 1.0mm
4. Material: FR-4
5. Thru hole: 3.0mm

# Appendix

## Zippy Piezo Inverter lamp current jumper

